



KAPPELER INSTITUTE RECORDINGS

ILLUSTRATIVE MATERIAL

**FROM ATOMISTIC THINKING
TO
CYBERNETIC COMPREHENSIVE CONSCIOUSNESS
(Audio code B-2)**

Max Kappeler

©1970, ©2005, Kappeler Institute for the Science of Being
All rights reserved



Kappeler Institute Publishing
P.O. Box 99735
Seattle, WA 98139-0735
Tel: (206)286-1617 • Fax: (206) 286-1675
mail@kappelerinstitute.org
www.kappelerinstitute.org
Division of Kappeler Institute for the Science of Being, USA
Seattle, WA USA

Contents

From Atomistic Thinking to Cybernetic Comprehensive Consciousness

(Audio code: B-2)

©1970, 2005 Kappeler Institute for the Science of Being

| AUDIO RECORDING NUMBER/SIDE | RECORDING SUBJECT |
|-----------------------------------|---|
| 1-A | Introduction <ul style="list-style-type: none">• Going out from the problem• Going out from the Infinite One |
| 1-B | Atomistic Thinking <ul style="list-style-type: none">• Definitions of Science• Development of consciousness |
| 2-A | Linear Thinking <ul style="list-style-type: none">• The law of creativity in the seven days of creation |
| 2-B | <ul style="list-style-type: none">• The law of creativity in evolution |
| 3-A | ...continued <ul style="list-style-type: none">• The 7,000 year-period in the Bible• The development of Jesus' life• The numerals of infinity versus the days of creation |
| 3-B | ...continued |
| | Functional Thinking |
| 4-A | <ul style="list-style-type: none">• Blending of ideas• Subtones of the days of creation• Thoughts versus ideas |
| 4-B | <ul style="list-style-type: none">• The synonymous terms• The nature and essence of God |
| EDITOR'S NOTE: | After Tape 4-B ends, there should be an additional 10 minutes or so of recording. See pg. 43 of the B-2 Illustrative Material for a written transcription of this lost section of tape. |
| 5-A | Review <ul style="list-style-type: none">• All ideas reflect every other idea |
| 5-B | ...continued <ul style="list-style-type: none">• The synonymous terms reflecting the four |
| 6-A | <ul style="list-style-type: none">• The synonymous terms and their counterfeits• Concept-building |
| 6-B | ...continued <ul style="list-style-type: none">• Principle and its idea |

From Atomistic Thinking to Cybernetic Comprehensive Consciousness – Audio Code B-2

© 1970, 2005 Kappeler Institute for the Science of Being, PO Box 99735, Seattle, WA 98139-0735. All rights reserved.

| | |
|------|---|
| 7-A | ...continued |
| | Going out from a system of reference |
| | Operational consciousness |
| | • Word, Christ, Christianity, and Science |
| 7-B | ...continued |
| 8-A | • The four Gospels reflecting the Word, Christ, Christianity, and Science |
| | • The law of creativity in the Word-order |
| 8-B | – Christ-order |
| | – Christianity-order |
| 9-A | ...continued |
| 9-B | ...continued |
| | – Science-order |
| 10-A | ...continued |
| | • The Word, Christ, Christianity, and Science-order in the Bible |
| 10-B | ...continued |
| | Structural Consciousness |
| | • The synonym Matrix |
| 11-A | • The Platform |
| | • The Word-Matrix – John Doorly’s Matrix |
| 11-B | ...continued |
| | • The Christ-Matrix – The Minor Prophets |
| 12-A | ...continued |
| 12-B | ...continued |
| | • The Christianity-Matrix – The Epistles |
| 13-A | ...Review |
| | • The Science-Matrix – The Textbook |
| 13-B | ...continued |
| 14-A | ...continued |
| 14-B | ...continued |
| | • The Mind-Matrix |
| 15-A | ...continued |
| 15-B | • The Matrix of Handling Evil |
| 16-A | ...continued |
| | • How to put the laws into today’s language |
| 16-B | ...continued |
| 17-A | ...continued |

The dimensional consciousness

-
- 17-B
 - The four levels of spiritual consciousness
 - The level of Christian Science
 - The level of absolute Christian Science
 - The level of divine Science and Science itself
 - 18-A
 - What these levels handle
...continued
 - The ascending and the descending thought
 - 18-B
 - ...continued
 - The tonality of the levels
 - Evil in the aspect of the levels
 - 19-A
 - ...continued
 - The levels and their synonymous terms
 - The synonymous terms in divine Science
 - 19-B
 - ...continued
 - The synonymous terms in absolute Christian Science
 - 20-A
 - ...continued
 - The synonymous terms in Christian Science
 - 20-B
 - Healing
...continued
 - 21-A
 - Cybernetic consciousness
 - Input, process, output, feedback
 - Comprehensive consciousness
 - Oneness in the Old Testament
 - Oneness in the New Testament
 - Oneness from the point of view of Principle
 - As the Word
 - As the Christ
 - 21-B
 - ...continued
 - As Christianity
 - As Science
 - 22-A
 - ...continued
 - Oneness in the Textbook
 - The Word-chapters
 - The Christ-chapters
 - Christianity-chapters
 - The Science-chapters
 - 22-B
 - ...continued
 - 23-A
 - ...continued
 - 23-B
 - Ordered steps of finding oneness with Being
 - 24-A
 - ...continued
 - ...continued

| | |
|------------|--|
| 24-A cont. | The development of the chapter on Animal Magnetism |
| 24-B | Mind-edition <ul style="list-style-type: none">• Spirit-edition• Soul-edition• Principle-edition• Life-edition• Truth-edition• Love-edition |
| 25-A | The development of Christian Science |
| 25-B | <ul style="list-style-type: none">• Phineas P. Quimby's influence• Edward Kimball's influence• Bicknell Young's influence• John W. Doorly's teaching |
| 26-A | ...continued <ul style="list-style-type: none">• Brief Summary |

From Atomistic Thinking to Cybernetic Comprehensive Consciousness

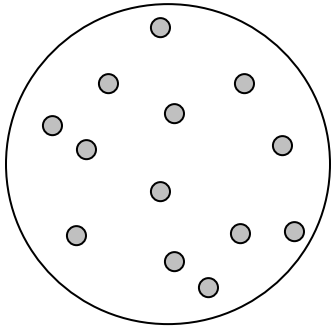

Unrelated

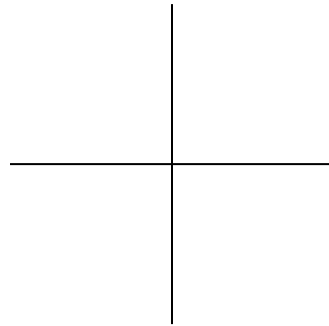

Intersection of Vertical and
Horizontal Categories

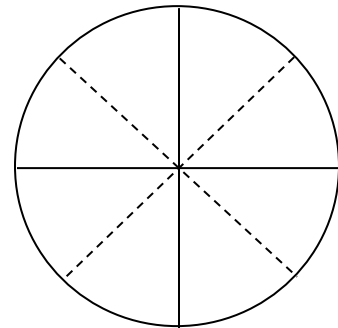

Each Point
Related

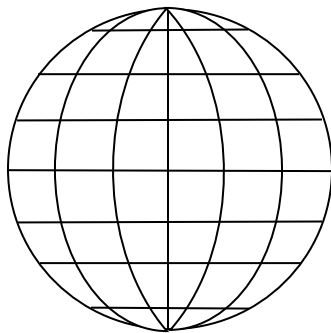

Superimposed
Network on Globe

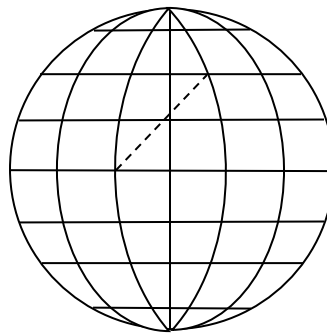

Relationship
of Points

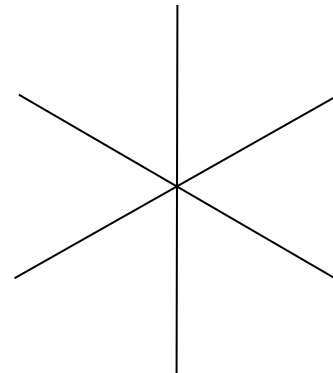

All Ideas
Connected

Law of Creativity

| Days of Creation | 3rd Degree (S&H 116) | | | Synonyms for God (S&H 465) |
|------------------------------------|--|------------------|-------------------|---|
| light: intelligence | wisdom | creative ability | law | Mind |
| firmament: separation | purity | unfoldment | order | Spirit |
| earth, seed in itself: identity | spiritual understanding | identity | rule | Soul |
| sun, moon, stars: government | spiritual power | classification | system | Principle |
| moving creatures: life | love | individuality | method | Life |
| man: dominion | health | consciousness | form | Truth |
| rest: fulfillment | holiness | unity with God | plan or design | Love |

Model of Being (The Chart)

| | | | | | | | | | | | | | | |
|---------------------------------------|--------------------------------|---|---|---|------------------|--|-------------|-------------|---------------|--------------|-------------|-------------|------------------|--|
| Science itself | infinite Principle | | | | | | | | | | | | | |
| | Word | Christ | Christianity | Science | | | | | | | | | | |
| divine Science | Life | Truth | Love | divine Principle, Love | | | | | | | | | | |
| absolute Christian Science | Life Truth Love | Truth Life Love | Life Love | Truth Love | | | | | | | | | | |
| Christian Science | Mind | Principle Life Truth Love Soul Spirit Mind | Principle Mind Soul Spirit Life Truth Love | <table style="margin: auto; border: none;"> <tr><td colspan="2">Principle</td></tr> <tr><td>Soul</td><td>Life</td></tr> <tr><td>Spirit</td><td>Truth</td></tr> <tr><td>Mind</td><td>Love</td></tr> <tr><td colspan="2">Principle</td></tr> </table> | Principle | | Soul | Life | Spirit | Truth | Mind | Love | Principle | |
| Principle | | | | | | | | | | | | | | |
| Soul | Life | | | | | | | | | | | | | |
| Spirit | Truth | | | | | | | | | | | | | |
| Mind | Love | | | | | | | | | | | | | |
| Principle | | | | | | | | | | | | | | |
| | Spirit | | | | | | | | | | | | | |
| | Soul | | | | | | | | | | | | | |
| | Principle | | | | | | | | | | | | | |
| | Life | | | | | | | | | | | | | |
| | Truth | | | | | | | | | | | | | |
| | Love | | | | | | | | | | | | | |

The 7 Synonymous Terms for God (in Word-order): **Mind, Spirit, Soul, Principle, Life, Truth, Love**

The 4-fold Operation of Being: **Word, Christ, Christianity, Science**

The 4 Levels of Spiritual Consciousness: **Science itself, divine Science, absolute Christian Science, Christian Science**

The Thousand-Year Periods of the Bible

The thousand-year periods of the Bible show how the ordered nature of God provides the step-by-step way out of belief and ignorance to a spiritual understanding of God, bringing life and peace.

| synonym | 1000-year period (symbol) | steps of unfolding understanding |
|-----------|--|--|
| Mind | Adam to Enoch (c. 4000 – 3000 B.C.) | awakening from ignorance (the mist of Eden) to follow the light of spiritual ideas (Enoch walks with God) |
| Spirit | Noah story with the flood to tower of Babel (c. 3000 – 2000 B.C.) | turning away from material beliefs to build an “ark” of understanding, remaining with the purity and onliness of spiritual ideas |
| Soul | Abraham, Isaac, Jacob, Joseph into Egypt, Moses leading people out of Egypt, entering the Promised Land, Joshua, Judges (c. 2000 – 1000 B.C.) | going the way from sense (Ur, Egypt) to Soul (Canaan, the Promised Land), exchanging a physical, corporeal identity for our spiritual selfhood |
| Principle | Samuel to the kings; the prophets (c. 1000 B.C. – 1 A.D.) | rejecting government by persons or material organizations and finding true government through prophecy, through the operation of Principle’s system of ideas, which interprets itself to mankind and governs the universe |
| Life | the life of Jesus, the apostles, Paul and the spreading of Christianity (c. 1 – 1000 A.D.) | laying down a mortal, material sense of life and accepting the newness of Life in and of Spirit as a gift of grace, bestowed on man through unity with Life |
| Truth | c. 1000 – 2000 A.D. | pioneering scientific consciousness, forcing the fall of mortal consciousness; grounding our understanding of true being and manhood in scientific methods rather than relying on blind faith |
| Love | c. 2000 A.D. onwards | the reign of divine Science: annihilation of fear, anxiety, provincialism, partiality, narrow-minded materialism; emergence of peace and fulfillment of the design of the Bible to establish a divinely scientific consciousness of God. |

Du Noüy

The Seven Stages of Evolution

There are seven undeniable fundamental facts that cannot be explained by natural science, yet form the backbone of evolution. These are as follows:

- | | | |
|---|--|-----------|
| 1. “The beginning of life” | First Cause, creative ability, divine Will, Intelligence | MIND |
| 2. “The evolution of life toward more and more complex forms” | Evolution, irreversible progress, diversification | SPIRIT |
| 3. “The actual result of this long process, namely, man and the human brain” | Freedom, incorporeality, identity | SOUL |
| 4. “The birth of thought, and of moral and spiritual ideas” | Relation to God, obedience, government, ideas, harmony, coordination (system), spiritual power | PRINCIPLE |
| 5. “The spontaneous and independent development of these ideas in different parts of the terrestrial globe” | Spontaneity, simultaneity, instantaneity, individuality | LIFE |
| 6. The “transformation of man into an active, responsible individual” | Ideal, dominion, victory, human dignity | TRUTH |
| 7. The existence of a telefinalistic plan | Telefinalistic plan, fulfillment | LOVE |

From Max Kappeler, *A Recent Theory of Evolution and Its Implications*

The numerals of infinity, called seven days
(S&H 520:10)

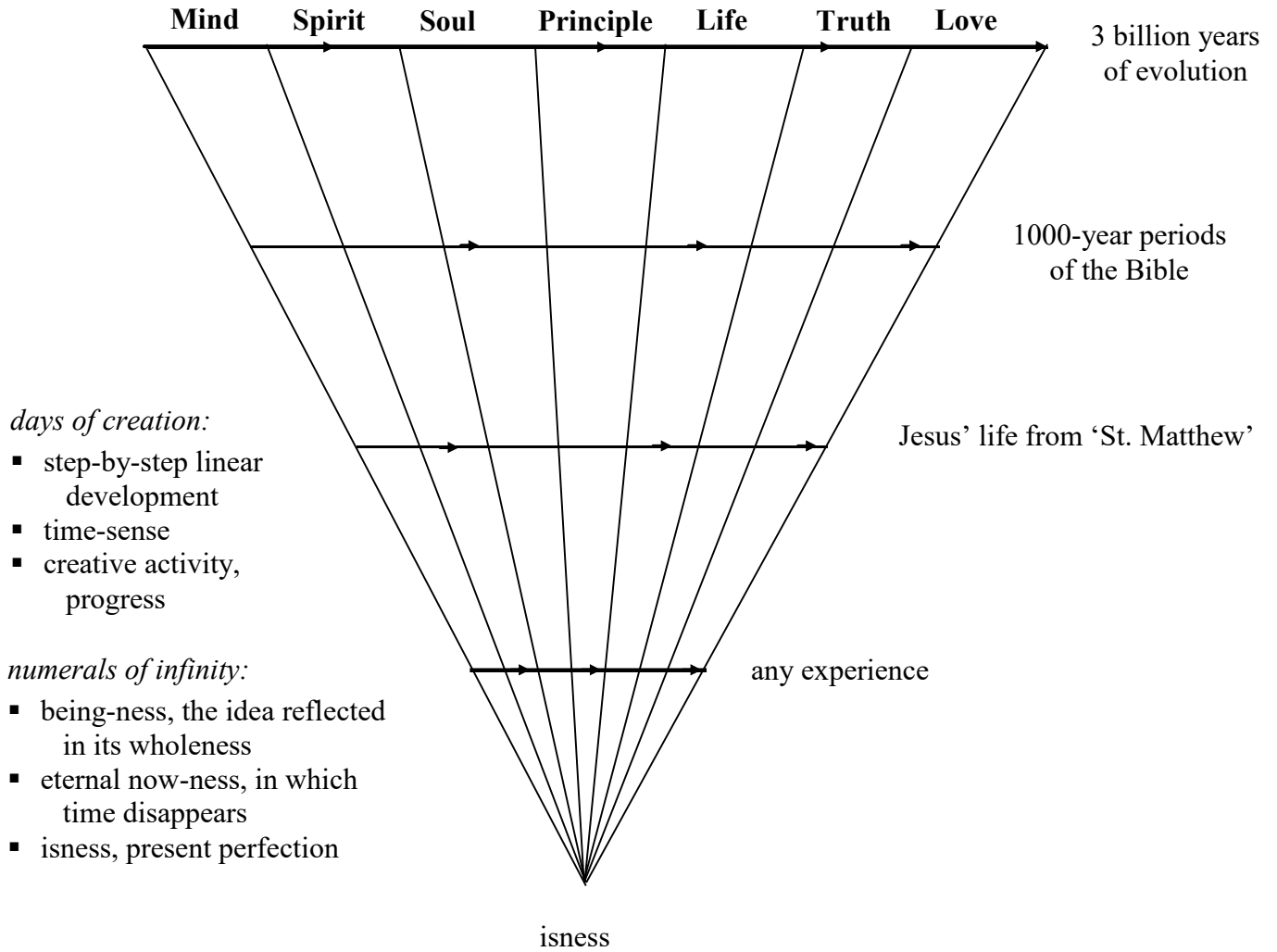

References:

Books by Max Kappeler:

Compendium for the Study of Christian Science, No. 2: The Seven Days of Creation, pp. 33–35.
The Seven Synonyms for God, chapter 2: the order of the seven days, also chapter 6: the Word-order.

Recordings by Max Kappeler:

A-6III: *Syllabus III*, 1978, Wilmington, DE, hours 8–10, 26–27.
B-2: *From Atomistic Thinking to Cybernetic Comprehensive Consciousness*, 1970, Ogunquit, ME, hours 2–5.
C-1G: *Ch. XV, "Genesis", The Structure of the Christian Science Textbook—Our Way of Life*, 1981, hours 13B–14A.
G-2: *The Science of Being—as I see it today*, Max Kappeler, 1970, London, England, hours 2B–3.
M-33: *The Days of Creation become the Numerals of Infinity*, (4 hours from B-2, #s 2–5).

Books by John Doorly:

God and Science—Symbols and their importance, Publisher: London, F. Muller [©1949], statement pp. 15–16, 41–48, Appendix I, pp. 216–218.
The Pure Science of Christian Science, pp. 18–19, 47–48.
Talks on the Science of the Bible, Vol. I "red-book," pp. 59–61, 63–65, 80–83, 155–157, 259–260, 272–274.
Talks on the Science of the Bible, Vol. II "red-book," pp. 54–55.
Talks at the Oxford Summer School, 1948, Vol. I, p. 20.
Talks at the Oxford Summer School, 1949, Vol. II, pp. 136–137, 145–146, 148–151, 156–157.

From Atomistic Thinking to Cybernetic Comprehensive Consciousness – Audio Code B-2

© 1970, 2005 Kappeler Institute for the Science of Being, PO Box 99735, Seattle, WA 98139-0735. All rights reserved.

Days of Creation—Numerals of Infinity
(S&H 520:10)

| Synonym | Day of Creation | Numeral of Infinity |
|----------------|--|---|
| Mind | beginning creator guides, leads wisdom | all, idea power law intelligence, knowing |
| Spirit | separation development birth purity | reality order substance understanding |
| Soul | resurrection reforms from sense to Soul balance | identity rule safety joy, freedom |
| Principle | interprets teaches proves practice | Science system foundational absolute |
| Life | exaltation aspiration inspiration love | immortality individuality ever-presence eternity |
| Truth | affirmative dominion health alternative | divine consciousness ideal form Christ |
| Love | rest fulfillment protects disposes | glory perfection ascension design |

References for the Days of Creation—Numerals of Infinity (*S&H* 520:10)

Books by Max Kappeler:

Compendium for the Study of Christian Science, No. 2: The Seven Days of Creation, pp. 33–35.
The Seven Synonyms for God, chapter 2: the order of the seven days, also chapter 6: the Word-order.

Recordings by Max Kappeler:

- A-6III: *Syllabus III*, 1978, Wilmington, DE, hours 26–27.
B-2: *From Atomistic Thinking to Cybernetic Comprehensive Consciousness*, 1970, Ogunquit, ME, hours 2–5.
C-1G: *Ch. XV, “Genesis”, The Structure of the Christian Science Textbook—Our Way of Life*, 1981, hours 13B–14A.
M-33: *The Days of Creation become the Numerals of Infinity*, (4 hours from B-2, #s 2–5).

Books by John Doorly:

God and Science—Symbols and their importance, Publisher: London, F. Muller [©1949], statement pp. 15–16, 41–48, Appendix I, pp. 216–218.
The Pure Science of Christian Science, pp. 18–19, 47–48.
Talks on the Science of the Bible, Vol. I “red-book,” pp. 59–61, 63–65, 80–83, 155–157, 272–274.
Talks on the Science of the Bible, Vol. II “red-book,” pp. 54–55.
Talks at the Oxford Summer School, 1948, Vol. I, p. 20.
Talks at the Oxford Summer School, 1949, Vol. II, pp. 136–137, 145–146, 148–151, 156–157.

Subtones of the Days of Creation

| Day | Biblical topic TONE | Biblical Subtopic | Subtone |
|-----|--|--|--|
| 1 | Light MIND | 1) There was light 2) Light was good, divided from darkness 3) Light was called Day | Mind Spirit Soul |
| 2 | Firmament SPIRIT | 1) Let there be a firmament to divide 2) Firmament divided the waters 3) The firmament is called Heaven | Mind Spirit Soul |
| 3 | Earth bringing forth; Seed in itself SOUL | 1) Water gathered together; dry land appears 2) Earth named and sea named 3) Let the earth bring forth grass, herb, etc. 4) Brought forth after its kind 5) Third day: resurrection | Mind Spirit Soul Principle Life |
| 4 | Sun, moon, stars PRINCIPLE | 1) Lights for signs, seasons, days, years 2) Give light upon the earth 3) Greater light ruling the lesser 4) Ruling over day and night 5) "Marking periods of progress" | Mind Spirit Soul Principle Life |
| 5 | Fish and fowl LIFE | 1) Waters bring forth abundantly the moving creature that has life and fowl that fly above the earth 2) Waters brought forth every living creature and every winged fowl 3) Blessed them: be fruitful, multiply, fill the earth 4) "Exalted beings" | Mind Spirit Soul Principle |
| 6 | Animals and man TRUTH | 1) Earth brings forth living creature, cattle, creeping thing, beast of the earth 2) It was good 3) Let us make man in our image after our likeness 4) Male and female created he them 5) Be fruitful, multiply, and replenish the earth 6) Man is given herb, tree; beast is given green herb 7) Everything very good | Mind Spirit Soul Principle Life Truth Love |
| 7 | Creation finished LOVE | 6) Heavens, earth, all the host of them finished 7) Work ended, rest from work | Truth Love |

Subtones of the Days of Creation (Genesis 1:3–2:2)

| | 1 st Day | 2 nd Day | 3 rd Day | 4 th Day | 5 th Day | 6 th Day | 7 th Day |
|------------------|---------------------|----------------------|----------------------------|------------------------------------|----------------------------|-----------------------------|---------------------|
| MIND | Mind/Mind 1:3 | Spirit/Mind 1:6 | Soul/Mind 1:9 | Principle/Mind 1:14 | Life/Mind 1:20 | Truth/Mind 1:24 | |
| SPIRIT | Mind/Spirit 1:4 | Spirit/Spirit 1:7 | Soul/Spirit 1:10 | Principle/Spirit 1:15 | Life/Spirit 1:21 | Truth/Spirit 1:25 | |
| SOUL | Mind/Soul 1:5 | Spirit/Soul 1:8 | Soul/Soul 1:11 | Principle/Soul 1:16 | Life/Soul 1:22 | Truth/Soul 1:26 | |
| PRINCIPLE | | | Soul/ Principle 1:12 | Principle/ Principle 1:17–18 | Life/ Principle 1:23 | Truth/ Principle 1:27 | |
| LIFE | | | Soul/Life 1:13 | Principle/Life 1:19 | | Truth/Life 1:28 | |
| TRUTH | | | | | | Truth/Truth 1:29-30 | Love/Truth 2:1 |
| LOVE | | | | | | Truth/Love 1:31 | Love/Love 2:2 |

The Day of Life, Truth, Love
(The Seven Days of Creation)
 (Gen. 1:3–2:2)

| Day of Creation | Life: The Creative | Truth: The Factual | Love: The Fulfilled |
|--|---|---|--|
| 1 st Day | Let there be light (1:3) | And God divided the light from the darkness (1:4) | And God called the light Day (1:5) |
| 2 nd Day | Let there be a firmament (1:6) | And God made the firmament (1:7) | And God called the firmament Heaven (1:8) |
| 3 rd Day | Let the dry land appear (1:9, 10) | Let the earth bring forth grass, and herb yielding seed, and the fruit tree yielding fruit after his kind, whose seed is in itself (1:11) | And the earth brought forth grass, and herb, and the tree yielding fruit (1:12, 13) |
| 4 th Day | Let there be lights...for signs and for seasons and for days, and years...to give light on the earth (1:14, 15) | God made two great lights...to rule the day and the night (1:16) | God set them in the firmament of the heaven...to rule (1:17–19) |
| 5 th Day | Let the waters bring forth abundantly the moving creature that hath life (1:20) | God created great whales, and every living creature that moveth...and every winged fowl (1:21) | God said, be fruitful and multiply (1:22, 23) |
| 6 th Day | Let the earth bring forth the living creature (1:24, 25) | Let us make man in our image, after our likeness. God created man in His own image (1:26, 27) | Be fruitful, and multiply...and have dominion (1:28–31) |
| 7 th Day (as Truth) (as Love) | Heavens... (2:1) On the seventh day God ended... (2:2) | And earth... (2:1) ...His work which He had made... (2:2) | and all the hosts of them were finished (2:1) ...And he rested... from all His work (2:2) |

References:

Recordings by Max Kappeler:

C-1G: *Ch. XV, "Genesis", The Structure of the Christian Science Textbook—Our Way of Life*, 1981, hours 10B, 15.

D-4: *Divine Cybernetics and the Self-operating "Dimensional Laws" of the One Being, God: Word (Part I), Word* 1971/72 – New York, hours 11–12.

Books by John Doorly:

Talks at the Oxford Summer School 1949, Vol. I, pages 7–48.

From Atomistic Thinking to Cybernetic Comprehensive Consciousness – Audio Code B-2

© 1970, 2005 Kappeler Institute for the Science of Being, PO Box 99735, Seattle, WA 98139-0735. All rights reserved.

Perfect Ideas – 1

| IDEA | MIND | SPIRIT | SOUL |
|--------------|----------|---------|----------|
| Intelligence | Creative | Ordered | Definite |
| | | | |
| | | | |
| Substance | | | |
| | | | |
| | | | |
| Joy | | | |
| | | | |
| | | | |
| Harmony | | | |
| | | | |
| | | | |
| Abundance | | | |
| | | | |
| | | | |
| Health | | | |
| | | | |
| | | | |
| Fulfillment | | | |
| | | | |
| | | | |

Perfect Ideas – 2

| PRINCIPLE | LIFE | TRUTH | LOVE |
|------------------|-------------|--------------|-------------|
| Operative | Inspiring | Has dominion | Planful |
| | | | |
| | | | |
| | | | |
| | | | |
| | | | |
| | | | |
| | | | |
| | | | |
| | | | |
| | | | |
| | | | |
| | | | |
| | | | |
| | | | |
| | | | |
| | | | |
| | | | |
| | | | |
| | | | |
| | | | |
| | | | |
| | | | |
| | | | |

Prism and Lens: Its Spiritually Scientific Development

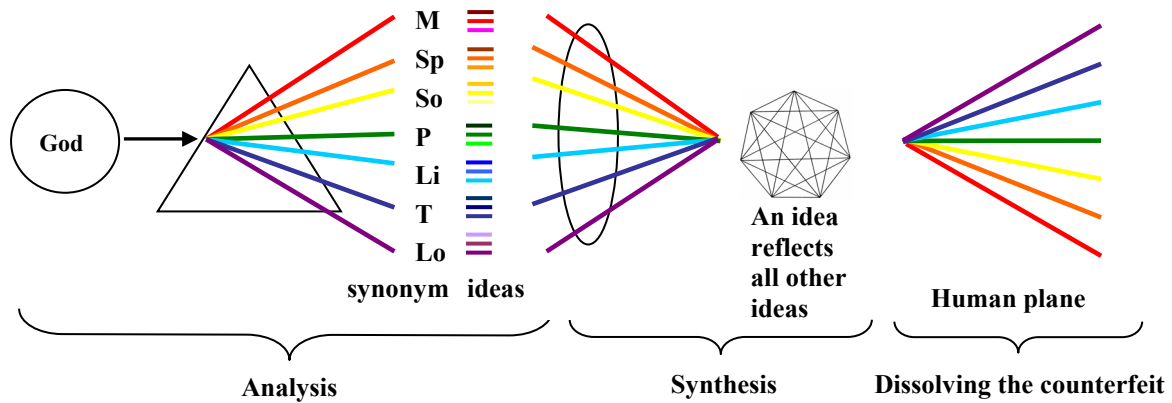
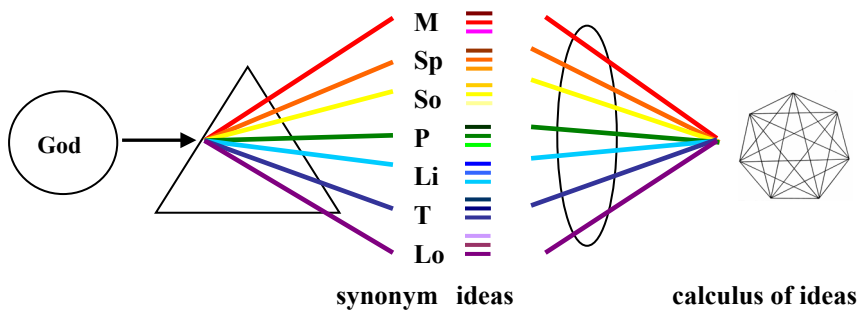
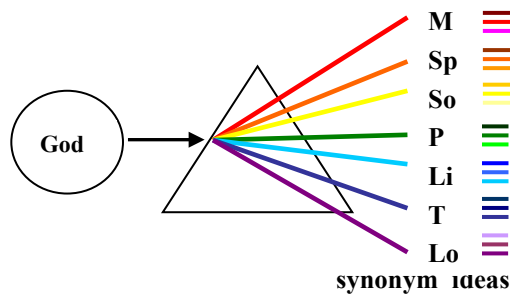
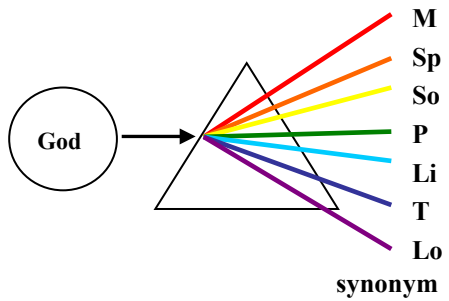

Prism and Lens: An Explanation of Mary Baker Eddy's Statements

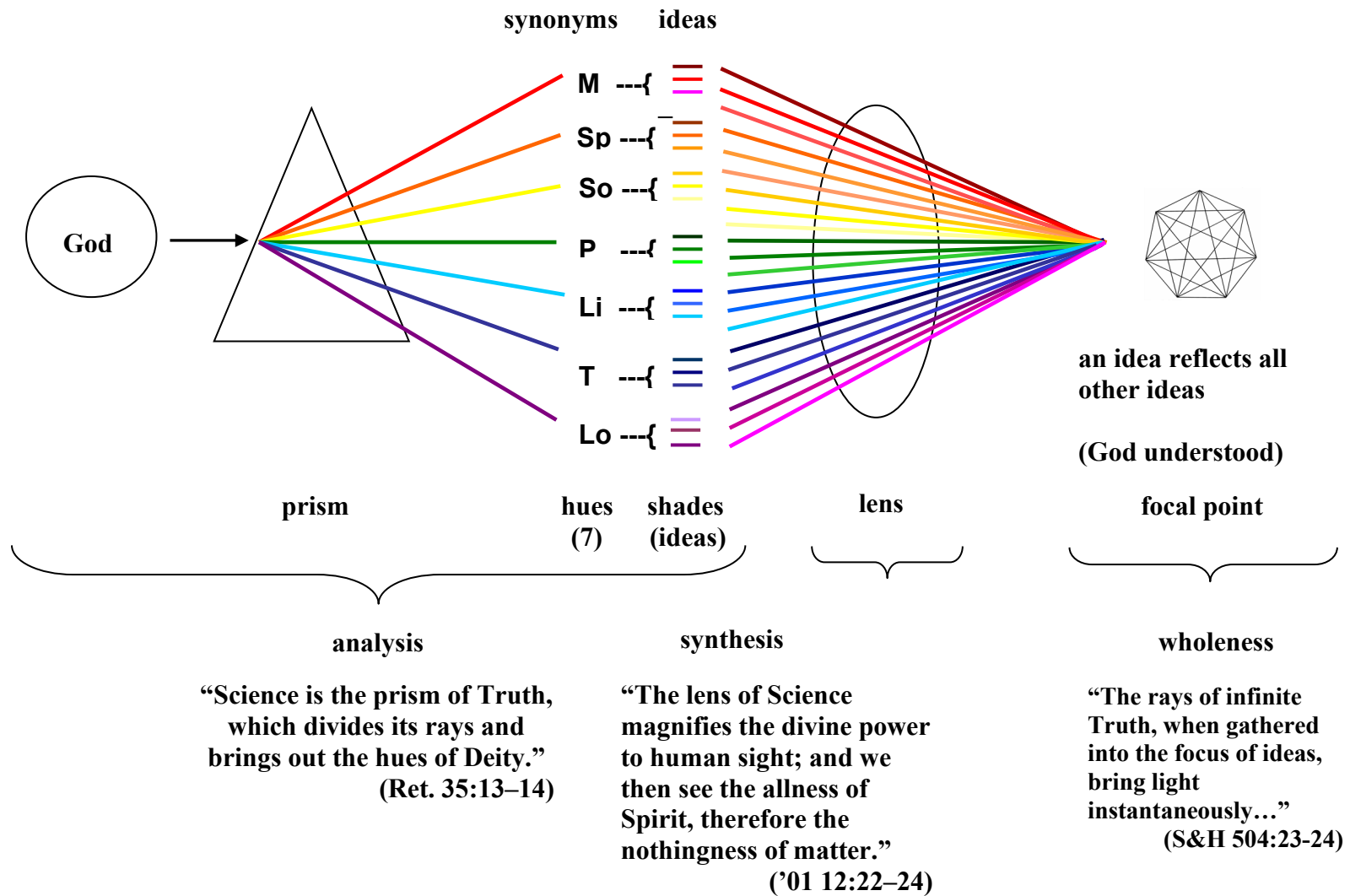

References for “Prism and Lens”:

Books by Max Kappeler:

Introduction to the Science of Christian Science.

The Bible in the Light of Christian Science, Vol. I: Genesis, p. 93.

Recordings by Max Kappeler:

A-1: *An Introduction to the Science of Christian Science*, 1962, Zürich, Switzerland, hour 3A.

A-4: *The Structure-principle of Being*, 1974, Wilmington, DE, hours 4–6.

B-2: *From Atomistic Thinking to Cybernetic Comprehensive Consciousness*, 1970, Ogunquit, ME, hours 4–5.

D-4: *Divine Cybernetics and the Self-operating “Dimensional Laws” of the One Being, God: Word (Part I), Word (Part II), The Christ (Part III), Christianity (Part IV)*, 1971/72, New York, hour 2.

G-2: *The Science of Being—as I see it today*, Max Kappeler, 1970, London, England, hour 3.



**The Seven Root Errors are Counterfeits of
Mind, Spirit, Soul, Principle, Life, Truth, Love**

| Original fact | | Counterfeit: simulation |
|--|----------------|---|
| Mind one Mind | exact opposite | many minds |
| Spirit Mind – substance (idea – substance) | exact opposite | mind and matter substance |
| Soul Mind – identity | exact opposite | mind and matter identity |
| Principle Mind’s laws govern | exact opposite | personal opinions govern |
| Life Mind, as Life is eternal | exact opposite | mind, as life, dies |
| Truth Mind, as Truth, is divine consciousness | exact opposite | mind, as truth, is human consciousness |
| Love Mind, as Love, is perfect | exact opposite | mind, as love, is imperfect |

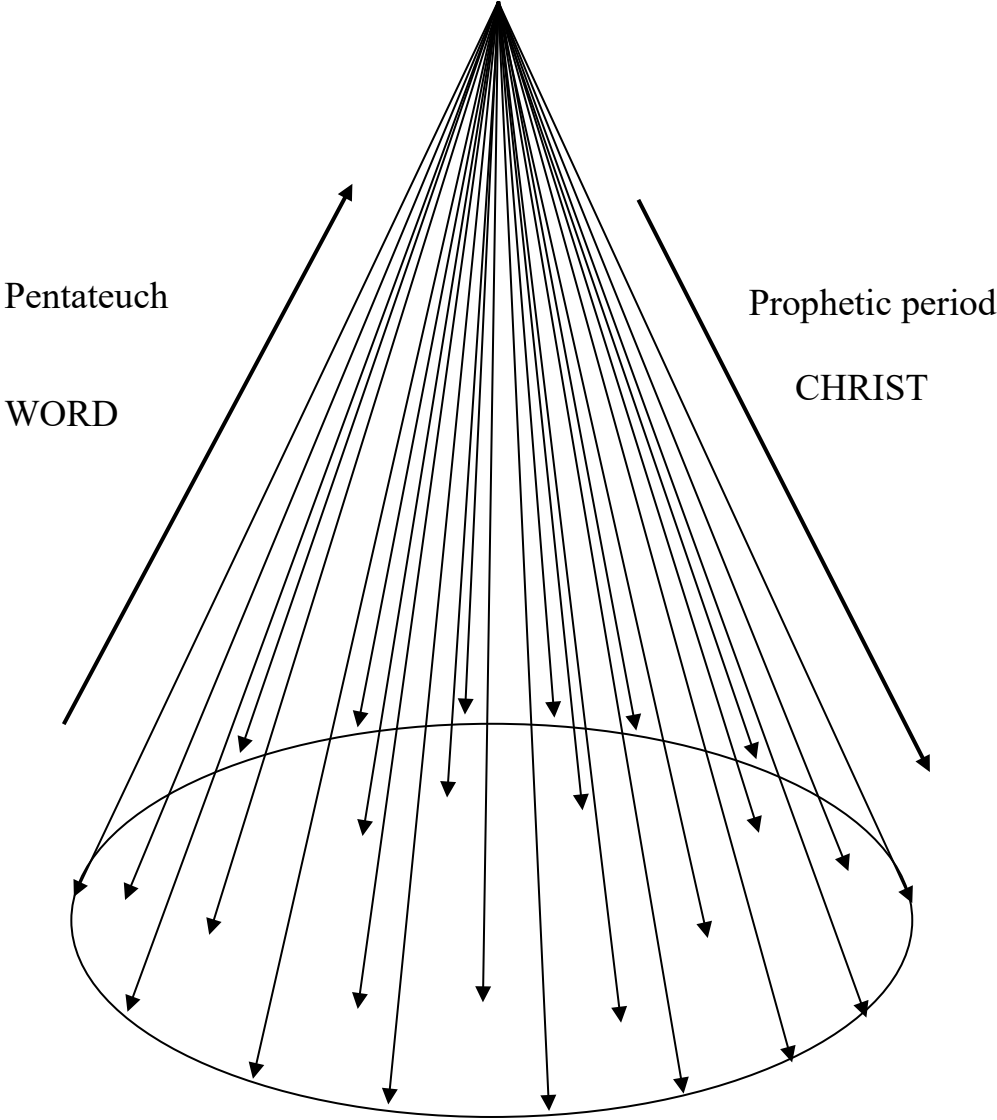
**Christ Translation—
coming down to all points**



Razor Blade

- 1) _____ to the eye
- 2)  to a microscope
- 3) □□□□□□□□□□ to chemistry
- 4) 

The Holy City

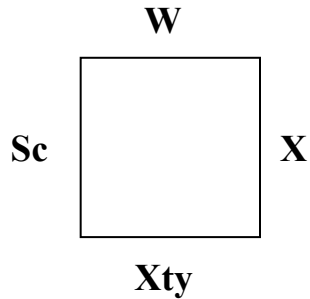

| WORD | CHRIST | CHRISTIANITY | SCIENCE |
|-------------|-------------|----------------|--------------------|
| incorporeal | divine | supreme | infinite |
| seeking | finding | using | being |
| addition | subtraction | multiplication | division |
| revelation | translation | reflection | interpretation |
| Law | Prophets | Jesus Christ | Science and Health |
| Matthew | Mark | Luke | John |
| omnipotence | omniscience | omnipresence | omniaction |
| line | plane | space | fourth dimension |
| Journal | Sentinel | Herald | Monitor |
| north | east | south | west |

W

p. 465

X

p. 115

Xty

p. 587

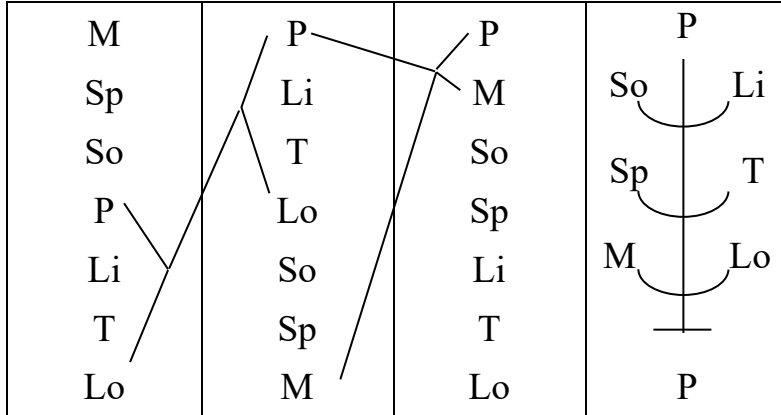
S

| | M | Sp | So | P | Li | T | Lo |
|----|----------|-----------|-----------|----------|-----------|----------|-----------|
| M | M/ M | Sp/ M | So/ M | P/ M | | | |
| Sp | M/ Sp | Sp/ Sp | So/ Sp | | | | |
| So | M/ So | Sp/ So | | | | | |
| P | M/ P | Sp/ P | | | | | |
| Li | M/ Li | | | | | | |
| T | M/ T | | | | | | |
| Lo | M/ Lo | | | | | | |

Each Side Reflects All Other Sides

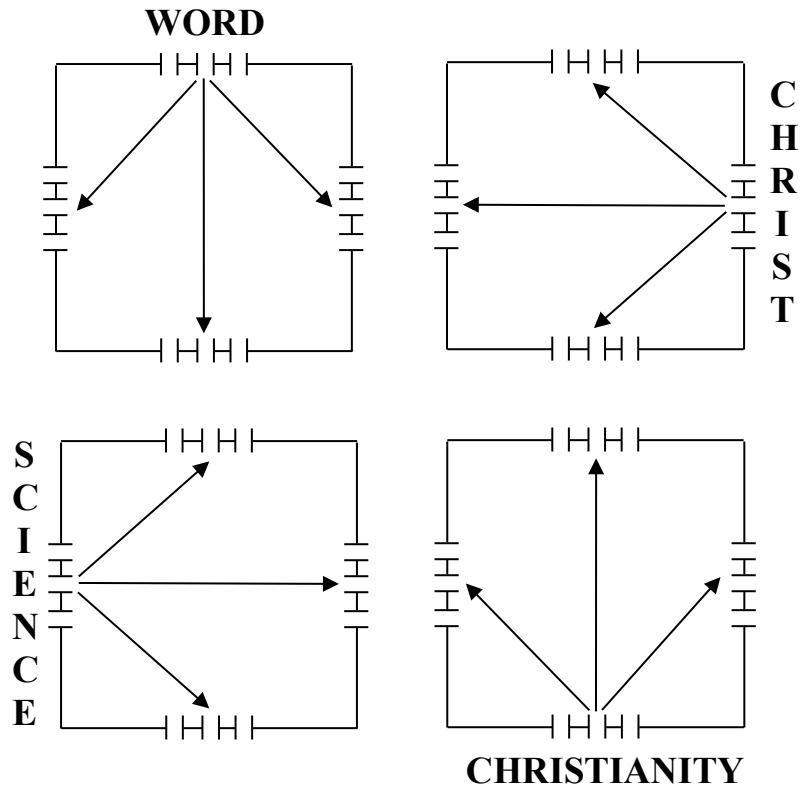

Matrix of the Four

| | W | X | <u>Xty</u> | Sc |
|-----|-------|-------|------------|--------|
| W | W/W | X/W | Xty/W | Sc/W |
| X | W/X | X/X | Xty/X | Sc/X |
| Xty | W/Xty | X/Xty | Xty/Xty | Sc/Xty |
| Sc | W/Sc | X/Sc | Xty/Sc | Sc/Sc |

Layout of the Platform

(in Science and Health with Key to the Scriptures, by Mary Baker Eddy, pp. 330–340)

| | | |
|---|--------|------------------------------------|
| Word (W): 8 questions = 4 statements, 2 aspects each | ↗ ↘ | absolute C.S. Christian Science |
| Christ (X): 8 questions = 4 statements, 2 aspects each | ↗ ↘ | absolute C.S. Christian Science |
| Christianity (Xty): 8 questions = 4 statements, 2 aspects each | ↗ ↘ | absolute C.S. Christian Science |
| Science (Sc): 8 questions = 4 statements, 2 aspects each | ↗ ↘ | absolute C.S. Christian Science |

| | 1–8 Creator WORD | 9–16 Translation CHRIST | 17–24 Reflection CHRISTIANITY | 25–32 Understanding SCIENCE |
|------------|---------------------|----------------------------|----------------------------------|--------------------------------|
| W | | | | |
| X | | | | |
| Xty | | | | |
| Sc | | | | |

Word-matrix

| | | | |
|--|--|--|--|
| | | | |
| | | | |
| | | | |
| | | | |

Science-matrix

| | | | |
|--|--|--|--|
| | | | |
| | | | |
| | | | |
| | | | |

Science & Health



W

← Sc

| | | | |
|--|--|--|--|
| | | | |
| | | | |
| | | | |
| | | | |

X →

Xty



Christ-matrix

| | | | |
|--|--|--|--|
| | | | |
| | | | |
| | | | |
| | | | |

Prophets

Christianity-matrix

| | | | |
|--|--|--|--|
| | | | |
| | | | |
| | | | |
| | | | |

Epistles

Science-order

Word-order (S&H 465): ordered sequence

Mind → Spirit → Soul → Principle → Life → Truth → Love

Science-order: order becomes structure (candlestick)

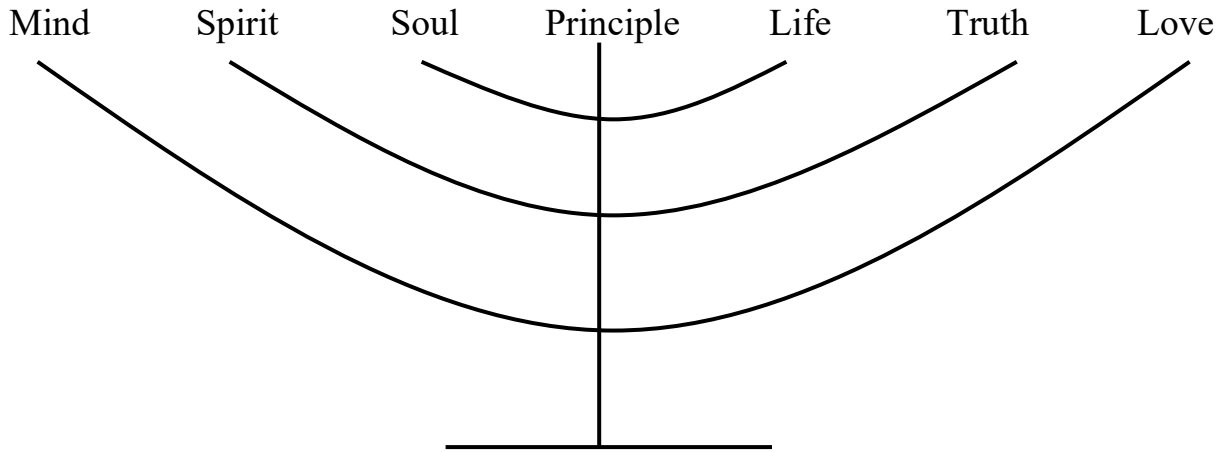

Science-order reveals structure

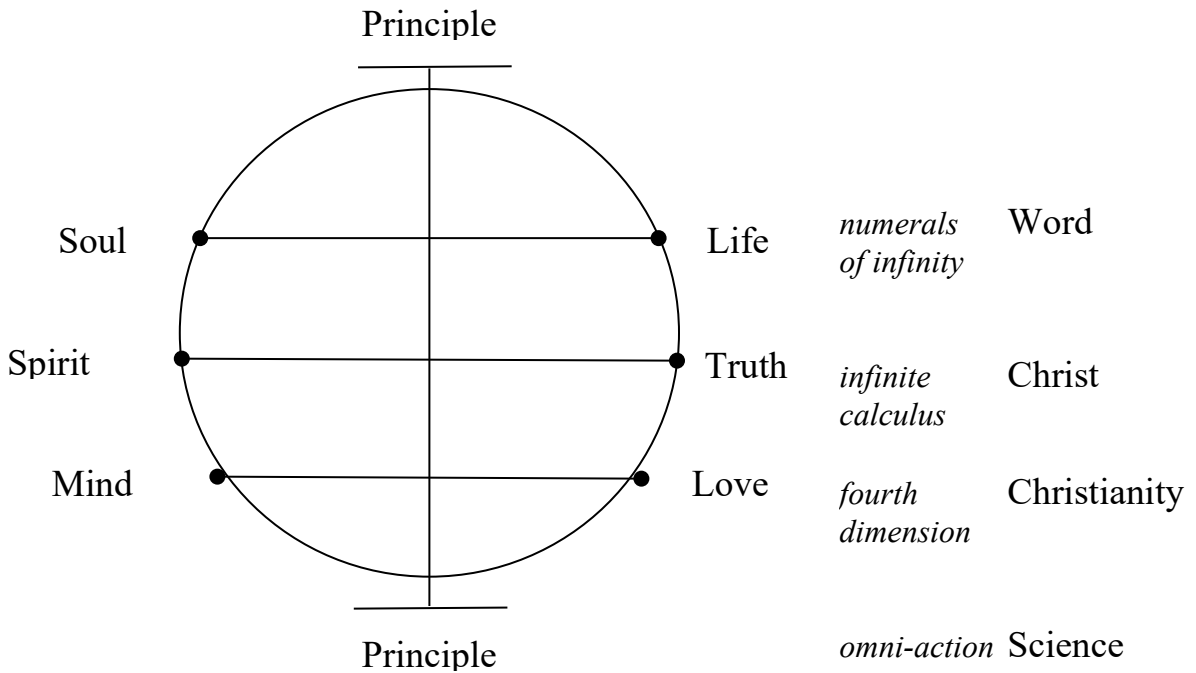

John Doorly's Matrix
as it was left to us by John W. Doorly (1950)

| | WORD | CHRIST | CHRISTIANITY | SCIENCE |
|---------------------|--|--|---|--|
| WORD | Order MIND SPIRIT SOUL | Manifestation PRINCIPLE LIFE TRUTH LOVE | Reflection PRINCIPLE MIND SOUL SPIRIT | Numerals of Infinity PRINCIPLE SOUL ——— LIFE |
| CHRIST | Identity SOUL PRINCIPLE LIFE | Translation TRUTH LOVE SOUL SPIRIT | Reality SPIRIT LIFE TRUTH | Infinite Calculus SPIRIT ——— TRUTH |
| CHRISTIANITY | Line LIFE TRUTH | Plane LOVE SOUL SPIRIT MIND | Space MIND SOUL SPIRIT LIFE TRUTH LOVE | Fourth Dimension MIND ——— LOVE |
| SCIENCE | Omnipotence LIFE TRUTH LOVE | Omniscience SOUL SPIRIT MIND | Omnipresence LIFE TRUTH LOVE | Omni-action PRINCIPLE |

From John W. Doorly, *The Pure Science of Christian Science* (London: The Foundational Book Company for the John W. Doorly Trust, 1949).

John Doorly's Matrix (Word-matrix)

| | WORD <i>(God's self-declaration)</i> | CHRIST <i>(the Christ-idea)</i> | CHRISTIANITY <i>(God's infinite self-reflection)</i> | SCIENCE <i>(God's self-interpretation as Science)</i> |
|--|--|--|---|---|
| WORD <i>(creative)</i> | <i>order</i> MIND SPIRIT SOUL | <i>manifestation</i> PRINCIPLE LIFE TRUTH LOVE | <i>reflection</i> PRINCIPLE MIND SOUL SPIRIT | <i>numerals of infinity</i> PRINCIPLE SOUL ——— LIFE |
| CHRIST <i>(Christ-selfhood)</i> | <i>identity</i> SOUL PRINCIPLE LIFE | <i>translation</i> TRUTH LOVE SOUL SPIRIT | <i>reality</i> SPIRIT LIFE TRUTH | <i>infinite calculus</i> SPIRIT ——— TRUTH |
| CHRISTIANITY <i>(Pure demonstration)</i> | <i>line</i> LIFE TRUTH | <i>plane</i> LOVE SOUL SPIRIT MIND | <i>space</i> MIND SOUL SPIRIT LIFE TRUTH LOVE | <i>fourth dimension</i> MIND ——— LOVE |
| SCIENCE <i>(God-being)</i> | <i>omnipotence</i> LIFE TRUTH LOVE | <i>omniscience</i> SOUL SPIRIT MIND | <i>omnipresence</i> LIFE TRUTH LOVE | <i>omni-action</i> PRINCIPLE |

References: Books by John W. Doorly:

The Pure Science of Christian Science (London: The Foundational Book Company for the John W. Doorly Trust, 1949), 2nd edition, p. 53.

Christian Science Practice (London: The Foundational Book Company for the John W. Doorly Trust, 1949), p. 358.

From Atomistic Thinking to Cybernetic Comprehensive Consciousness – Audio Code B-2

© 1970, 2005 Kappeler Institute for the Science of Being, PO Box 99735, Seattle, WA 98139-0735. All rights reserved.

The Christ-matrix

| | WORD <i>The mono-potency of God, good</i> | CHRIST <i>The manifestation of the Christ-likeness</i> | CHRISTIANITY <i>The preservation of the idea</i> | SCIENCE <i>The operation of the idea in its Principle</i> |
|---|---|--|--|---|
| Word <i>the divine purpose defined</i> | Hosea | Obadiah | Nahum | Haggai |
| Christ <i>the enforcement of the translation of two-ness into oneness</i> | Joel | Jonah | Habakkuk | Zechariah |
| Christianity <i>the disappearance of evil and the appearance of good rendered inescapable</i> | Amos | Micah | Zephaniah | Malachi |
| Science <i>the understanding of God</i> | Isaiah | Jeremiah | Ezekiel | Daniel |

References:

Books by Max Kappeler:

The Minor Prophets in the Light of Christian Science (the entire book is devoted to this subject).

Recordings by Max Kappeler:

B-2: *From Atomistic Thinking to Cybernetic Comprehensive Consciousness*, 1970, Ogunquit, ME, hours 11B-12.

E-2: *The Matrix of Immortality: Code of divine laws*, 1974, Wilmington, DE, hours 16-22A.

F-1: *The Minor Prophets in the Light of Christian Science*, 1962, Los Angeles, CA, 32 hours.

G-2: *The Science of Being—as I see it today*, 1970, London, England, hours 6-7.

From Atomistic Thinking to Cybernetic Comprehensive Consciousness – Audio Code B-2

© 1970, 2005 Kappeler Institute for the Science of Being, PO Box 99735, Seattle, WA 98139-0735. All rights reserved.

The Christianity-matrix
 = *the reciprocal relation of man to:*

| | WORD <i>the grace of God</i> | CHRIST <i>the glory of Christ</i> | CHRISTIANITY <i>the idea of man's perfection</i> | SCIENCE <i>the Science of man</i> |
|--|--|---|--|---|
| Word <i>accepting the new faith</i> | Romans | Galatians | Colossians | Pastoral Epistles (I Timothy) (II Timothy) (Titus) |
| Christ <i>claiming the new faith</i> | I Corinthians | Ephesians | I Thessalonians | Philemon |
| Christianity <i>steadfastly abiding in the new faith</i> | II Corinthians | Philippians | II Thessalonians | Hebrews |
| Science <i>proving the new faith by living it</i> | James | I & II Peter | I, II, III John | Jude |

References:

Books by Max Kappeler:

The Epistles in the Light of Christian Science (the entire book is devoted to this subject).

Recordings by Max Kappeler:

B-2: *From Atomistic Thinking to Cybernetic Comprehensive Consciousness*, 1970, Ogunquit, ME, hours 12B–13A.

E-2: *The Matrix of Immortality: Code of divine laws*, 1974, Wilmington, DE, hours 22–23.

F-2: *The Epistles in the Light of Christian Science*, 1962, Los Angeles, CA, 31 hours.

G-2: *The Science of Being— as I see it today*, 1970, London, England, hours 6–7.

From Atomistic Thinking to Cybernetic Comprehensive Consciousness – Audio Code B-2

© 1970, 2005 Kappeler Institute for the Science of Being, PO Box 99735, Seattle, WA 98139-0735. All rights reserved.

The Matrix of Christian Science

(in *Science and Health with Key to the Scriptures*, by Mary Baker Eddy, Chapters I–XVI)

| absolute standpoint (j) relative standpoint (i) | WORD revelation of God’s nature | CHRIST translation of God to idea | CHRISTIANITY the realm of ideas | SCIENCE Principle and idea is one |
|---|---|--|---|---|
| Word accepting the proposition | CHAPTER I <i>Prayer</i> revelation of God’s nature by accepting God’s nature in us | CHAPTER V <i>Animal Magnetism Unmasked</i> As we accept the Christ- translation, the ungodlike is translated back into its native nothingness | CHAPTER IX <i>Creation</i> As we accept the realm of ideas, the ideational universe reveals itself to us | CHAPTER XIII <i>Teaching Christian Science</i> By accepting our oneness with Principle, we are Principle- idea |
| Christ power of manifestation in spite of error | CHAPTER II <i>Atonement and Eucharist</i> God’s nature manifests itself in us in spite of the ungodlike in us | CHAPTER VI <i>Science, Theology, Medicine</i> The Christ-translation manifests itself by translating the false constituents into the true constituents of Being | CHAPTER X <i>Science of Being</i> The dynamic power of manifestation of ideas dissolves both latent and concrete error | CHAPTER XIV <i>Recapitulation</i> Principle-idea manifests itself as a calculus of ideas and corrects the calculus of human beliefs |
| Christianity exalted being | CHAPTER III <i>Marriage</i> God’s nature demonstrates itself in us as a higher humanhood | CHAPTER VII <i>Physiology</i> The Christ-translation translates mortals into immortals | CHAPTER XI <i>Some Objections Answered</i> The perfect reflection of ideas exalts a theoretical Christianity to a practical Christianity | CHAPTER XV <i>Genesis</i> In the oneness of Principle and idea, creation is exalted in its divine Principle |
| Science scientific understanding | CHAPTER IV <i>Christian Science vs. Spiritualism</i> God’s nature can be understood only by scientific methods of understanding | CHAPTER VIII <i>Footsteps of Truth</i> The Christ-translation translates an unscientific consciousness into a scientific consciousness | CHAPTER XII <i>Christian Science Practice</i> A scientific understanding of ideas heals | CHAPTER XVI <i>The Apocalypse</i> Scientific understanding recognizes that on all levels of existence, only the idea of Principle is ever going on |

From *Atomistic Thinking to Cybernetic Comprehensive Consciousness – Audio Code B-2*

© 1970, 2005 Kappeler Institute for the Science of Being, PO Box 99735, Seattle, WA 98139-0735. All rights reserved.

References for “The Matrix of Christian Science”

Books by Max Kappeler:

The Development of the Christian Science Idea and Practice ©2004, 2nd edition, pp. 8–18 (the development of the Science and structure of the textbook).

Epitomes for the Spiritually Structured Interpretation of the Christian Science Textbook (the entire book is presents an elaboration of this subject).

The Science of the Oneness of Being in the Christian Science Textbook, Appendix, Table 3, also pp. 263–267.

The Structure of the Christian Science Textbook (the entire book is devoted to explaining this subject).

‘*Stately Science Pauses Not,*’ booklet, pp. 31–47.

When I think of John W. Doorly...II—Introduction to the Matrix Consciousness, ©2002.

Recordings by Max Kappeler:

B-2: *From Atomistic Thinking to Cybernetic Comprehensive Consciousness*, 1970, Ogunquit, ME, hours 13–14.

C-1: *The Structure of the Christian Science Textbook, our way of Life*, an extensive series of talks spanning the last 30 years of Series talks on the Textbook’s structure, covering both the structure of each chapter and the structure of the textbook as a whole. (see the Kappeler Institute Writings and Recordings Catalog or visit the Kappeler Institute website at www.kappelerinstitute.org)

C-2: *The Christian Science Textbook — a workshop on text-interpretation*, an analysis of the structure of the first five chapters to illustrate Series the structural and scientific method of text-interpretation. (see the Kappeler Institute Writings and Recordings Catalog or visit the Kappeler Institute website at www.kappelerinstitute.org)

C-4: *The Matrix of “Science and Health”: An overview*, 1975, Wilmington, DE, hours 7–24.

C-6: *Exercises in Culturing Consciousness According to the Matrix of “Science and Health,”* 1976, Ilkley, England, 26 hours, especially hours 2B–9A.

E-2: *The Matrix of Immortality: Code of divine laws*, 1974, Wilmington, DE, hours 11–16A.

M-20: *The Structure of the Christian Science Textbook: An Overview*, 2 hours.

The translation of “St. Matthew” into Science

| <i>Biblical symbols</i> | <i>metaphysics</i> | <i>Science</i> |
|-------------------------|--|-------------------------------------|
| 1) genealogy | parent Mind | Mind |
| 2) baptisms | purification | Spirit |
| 3) temptations | identity | Soul |
| 4) Sermon on the Mount | interpretation | Principle |
| 5) healings | fullness of life | Life |
| 6) What is man? | calculus of ideas | Truth |
| 7) resurrection | fulfillment | Love |
| | } specific linear interpretation | } general structural creative |

The formulation of phenomena into a scientific law

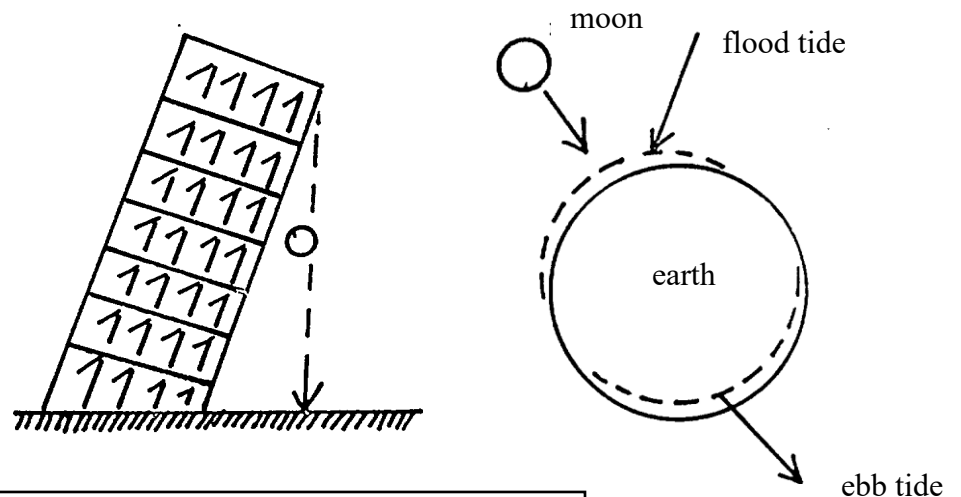

law:

$$F = g \frac{m_1 \cdot m_2}{r^2}$$

References:

Recordings by Max Kappeler:

B-2: *From Atomistic Thinking to Cybernetic Comprehensive Consciousness*, 1970, Ogunquit, ME, hour 16.

D-4: *Divine Cybernetics and the Self-operating “Dimensional Laws” of the One Being, God*, 1971/72, New York, hour 12B.

E-1: *The Structure of Being and its Universal Laws*, 1973, New York, hour 29B.

G-2: *The Science of Being—as I see it today*, 1970, London, England, #7.

From Atomistic Thinking to Cybernetic Comprehensive Consciousness – Audio Code B-2

© 1970, 2005 Kappeler Institute for the Science of Being, PO Box 99735, Seattle, WA 98139-0735. All rights reserved.

Mind Matrix

(in *Science and Health with Key to the Scriptures*, by Mary Baker Eddy, Chapters I–XVI)

| Mind | WORD all-Mind | CHRIST all-power of Mind | CHRISTIANITY allness of ideas | SCIENCE Mind and Mind-idea is one |
|---|---|---|---|--|
| Word Accepting the proposition | <i>I. Prayer</i> Mind is all-knowing | <i>V. Animal Magnetism Unmasked</i> Only the power of Mind operates, working out only good | <i>IX. Creation</i> Mind is the creator of all as idea | <i>XIII. Teaching Christian Science</i> The mind of the student must be in unity with the divine Mind |
| Christ the power of manifestation in spite of error | <i>II. Atonement and Eucharist</i> the power of Mind over material intelligence and matter | <i>VI. Science, Theology, Medicine</i> The all-power of Mind, not matter, is the all-redeeming power | <i>X. Science of Being</i> All is Mind and its infinite manifestation | <i>XIV. Recapitulation</i> All that is going on is Mind and Mind-idea |
| Christianity exalted being | <i>III. Marriage</i> Mind is superior to the human mind and matter | <i>VII. Physiology</i> To Mind and with Mind all is possible; Mind governs and controls all | <i>XI. Some Objections Answered</i> Before the unlimited divine Mind, all limited views must yield | <i>XV. Genesis</i> Mind constantly reveals itself as an ordered unfoldment of ideas |
| Science scientific understanding | <i>IV. Christian Science vs. Spiritualism</i> Mind alone possesses the faculty of knowing | <i>VIII. Footsteps of Truth</i> The understanding that there is only one Mind makes all harmonious and perfect | <i>XII. Christian Science Practice</i> The understanding that all is Mind heals | <i>XVI. The Apocalypse</i> The understanding of Mind uncovers the illusions of mortal mind |

References:

Recordings by Max Kappeler:

B-2: *From Atomistic Thinking to Cybernetic Comprehensive Consciousness*, 1970, Ogunquit, ME, hours 14B–15.

G-2: *The Science of Being—as I see it today*, 1970, London, England, hour 5.

Books by Max Kappeler:

The Seven Synonyms for God, Chapter 9, which also includes the matrices for the other synonyms. *Compendium for the Study of Christian Science, No. 7: Principle*, Appendix I, pp. 212–214, presents the tone of Principle in each chapter.

From Atomistic Thinking to Cybernetic Comprehensive Consciousness – Audio Code B-2

© 1970, 2005 Kappeler Institute for the Science of Being, PO Box 99735, Seattle, WA 98139-0735. All rights reserved.

The Matrix of Handling Evil

(in Science and Health with Key to the Scriptures, by Mary Baker Eddy, Chapters I–XVI)

| | WORD <i>evil must be mastered</i> | CHRIST <i>the power of Truth destroys evil; evil has no power</i> | CHRISTIANITY <i>demonstrating the superiority of good over evil</i> | SCIENCE <i>by proving good, evil is disproved</i> |
|---|---|---|---|--|
| Word <i>Accepting the proposition</i> | I. Prayer the desire to be delivered from evil: deliver us from evil | V. Animal Magnetism Unmasked Science has the power to despoil evil, for evil is no power, action or law | IX. Creation Mortals must let themselves be used by good instead of by evil | XIII. Teaching Christian Science By resisting, exposing and denouncing evil, the nothingness of evil can be proved |
| Christ <i>the power of manifestation in spite of error</i> | II. Atonement and Eucharist the command to cast out evil | VI. Science, Theology, Medicine The power of Truth casts out evil | X. Science of Being The somethingness of good demonstrates the nothingness of evil | XIV. Recapitulation In the allness of God, good, evil has no place |
| Christianity <i>exalted being</i> | III. Marriage The good must have ascendancy over evil | VII. Physiology The only power of evil is to destroy itself | XI. Some Objections Answered denying that God either knows evil, made evil, or cooperates with evil | XV. Genesis Truth annihilates the belief in evil by reducing it to its nothingness |
| Science <i>scientific understanding</i> | IV. Christian Science vs. Spiritualism Understanding God, good, keeps evil in check | VIII. Footsteps of Truth Discernment of understanding good destroys the so-called power of evil | XII. Christian Science Practice Understanding the supremacy of good causes evil to disappear | XVI. The Apocalypse By understanding God, good, the nothingness of evil is made manifest |

References to “The Matrix of Handling Evil”:

Recordings by Max Kappeler:

- A-6II: Syllabus II, 1977, hours 22–23.
- B-2: *From Atomistic Thinking to Cybernetic Comprehensive Consciousness*, 1970, Ogunquit, ME, hours 15B–16, 24.
- B-3 *Christian Science Practice: based on the Science of divine revelation*, 1976, Wilmington, DE, hours 3–8.
- C-1AN: CH. V, “Animal Magnetism Unmasked,” *The Structure of the Christian Science Textbook—Our Way of Life*, hours 2–4, 7B–8.
- C-6: *Exercises in Culturing Consciousness According to the Matrix of “Science and Health,”* 1976, Ilkley, England, hours 10–11.
- G-2: *The Science of Being—as I see it today*, 1970, London, England, hour 5.
- X-5 *The Problem of Handling Evil*, 6 cassettes from B-3 (hours 3–8).

Books by Max Kappeler:

Animal Magnetism — Unmasked, pp. 47–81.

Notes on Handling Evil, pamphlet.

Books by John Doorly:

Christian Science Practice, pp. 328–329, 344–346, 349–355.

Talks on the Science of the Bible, #70 “blue-book,” pp. 15–20.

Talks on the Science of the Bible, Vol. VI “red-book,” pp. 108–110, 231–232, 289–290.

Talks on the Science of the Bible, Vol. VII “red-book,” pp. 13–15, 16–19, 42, 83–85, 283–289.

From Atomistic Thinking to Cybernetic Comprehensive Consciousness – Audio Code B-2

© 1970, 2005 Kappeler Institute for the Science of Being, PO Box 99735, Seattle, WA 98139-0735. All rights reserved.

DIMENSIONALISM (against reductionism)

Diagram A

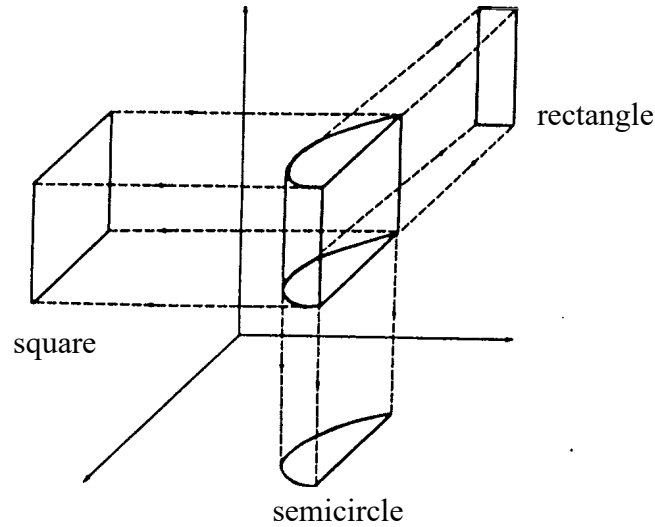

Diagram B

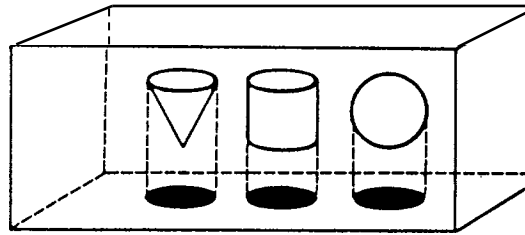
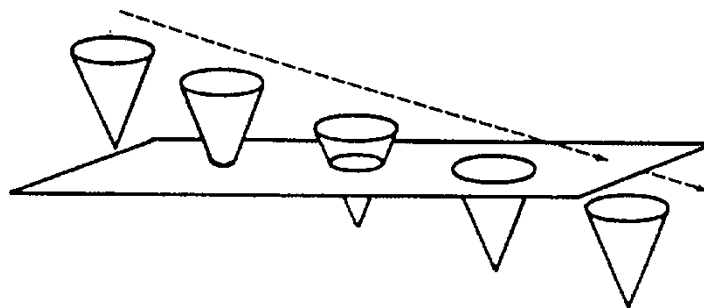

Diagram C



References:

Recordings by Max Kappeler:

- A-4: *The Structure-principle of Being*, 1974, Wilmington, DE, hour 20.
- A-6V: *Syllabus V*, 1980, hour 3.
- B-2: *From Atomistic Thinking to Cybernetic Comprehensive Consciousness*, 1970, Ogunquit, ME, hour 17.
- D-4: *Divine Cybernetics and the Self-operating "Dimensional Laws" of the One Being, God: Word (Part I), Word (Part II), The Christ (Part III), Christianity (Part IV)*, 1971/72, New York, hour 3.

- G-2: *The Science of Being—as I see it today*, Lecture, 1970, London, England, hours 6–7.

Books by Max Kappeler:

- The Seven Synonyms for God*, Chapter 7.
- The Science of the Oneness of Being in the Christian Science Textbook*, pp. 49–51.

From Atomistic Thinking to Cybernetic Comprehensive Consciousness – Audio Code B-2

© 1970, 2005 Kappeler Institute for the Science of Being, PO Box 99735, Seattle, WA 98139-0735. All rights reserved.

Christian Science Practice

| Practitioner | | | | Patient |
|---------------------|---|--|---|---|
| | Love and Mind <i>How he himself must be</i> | <i>Truth and Mind</i> <i>The Truth he knows</i> | <i>Life and Soul</i> <i>His Method</i> | Love } Truth } <i>and Spirit</i> Life } <i>Healing process</i> |
| Mind | seeing only perfection | Mind is all | law of Mind | <i>Love + Spirit</i> based on Mind-science |
| Spirit | good and pure | Spirit is the only reality | Spirit: the only substance | creates order |
| Soul | selfless | incorporeality and sinlessness of man | rule of Soul: supremacy; | <i>Truth + Spirit</i> translation takes place |
| Principle | winning his own pardon scientifically | Science and metaphysics: basis of demonstration | government: omnipotence of Principle | reaching every part of the system |
| Life | experiencing fullness of life; laying down the mortal concept | man maintained by fullness of Life | immortality: self-supporting Life | renewal of Life <i>Life + Spirit</i> eternal life |
| Truth | growing into Christian manhood | man's dominion through consciousness | form of man: consciousness of Truth | perfect health |
| Love | anticipating fulfillment | man's perfection; no penalty | fulfillment: perfection of Love | solution for every problem |

References:

Books by Max Kappeler:

Epitomes for the Spiritually Structured Interpretation of the Christian Science Textbook, pp. 2–10.
The Science of the Oneness of Being in the Christian Science Textbook, pp. 183–196.
The Structure of the Christian Science Textbook, Vol. I.: Revelation of the Structure, pp. 116–135.

Books by John Doorly:

Christian Science Practice

Recordings by Max Kappeler:

A-4: *The Structure-principle of Being*, Wilmington, DE, hours 24–25.
 C-6: *Exercises in Structuring Consciousness According to the Matrix of "Science and Health,"* Ilkley, England, 26 hours
 C-1P: *CH. XII, "Christian Science Practice", The Structure of the Christian Science Textbook—Our Way of Life*, 17 hours.

From Atomistic Thinking to Cybernetic Comprehensive Consciousness – Audio Code B-2

© 1970, 2005 Kappeler Institute for the Science of Being, PO Box 99735, Seattle, WA 98139-0735. All rights reserved.

Divine Cybernetic Model

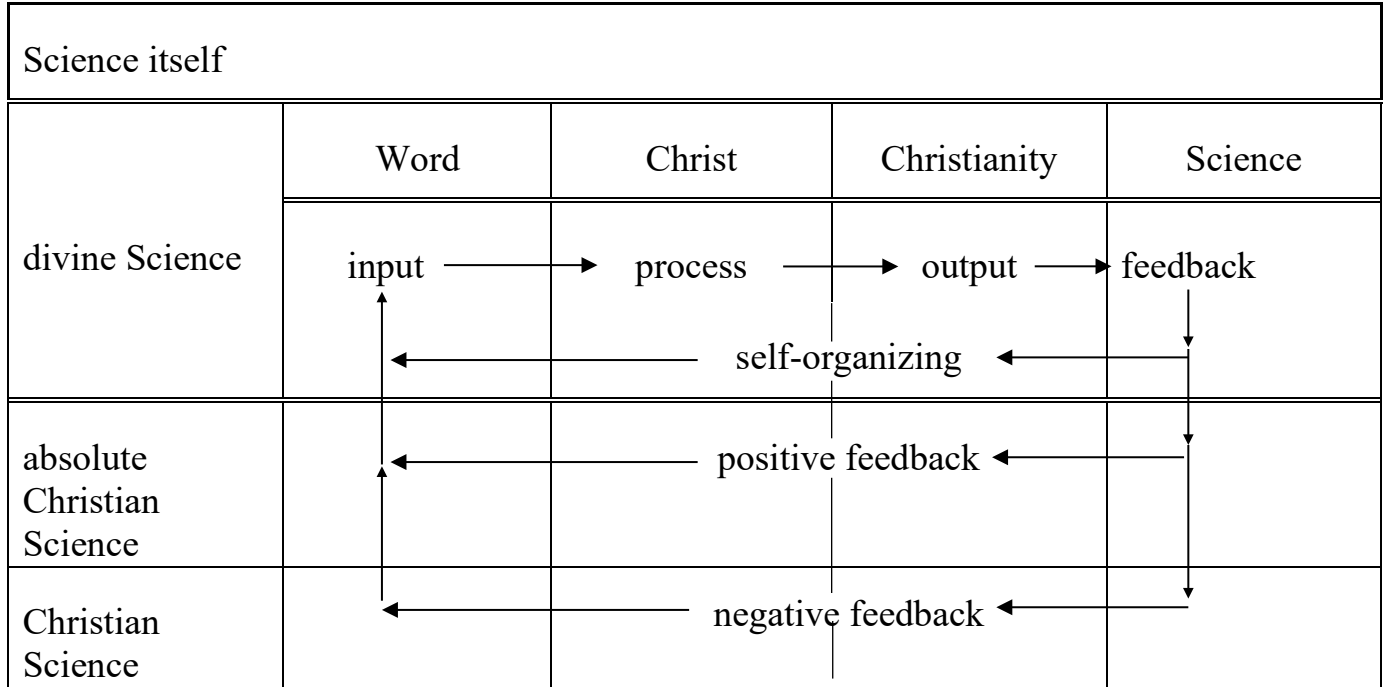

divine cybernetics presents:

| | |
|----------------------------------|---|
| Science itself | the one infinite Being |
| divine Science | as a self-organizing system, running on a self-regulating circuit |
| absolute Christian Science | that has positive feedback (is error-preventing) |
| Christian Science | as well as negative feedback (is error-correcting) |

Recommended references for studying this subject:

Recordings by Max Kappeler:

- B-1: *A Survey of the Fundamentals of Christian Science*, hours 9–10.
- B-2: *From Atomistic Thinking to Cybernetic Comprehensive Consciousness*, 1970, Ogunquit, ME, hour 20B.
- D-2: *Divine Cybernetics: the proto-science, the integral Science*, 1969, Braunwald, Switzerland, hours 1–6, 11B (the class goes on to explain The Model of Being in the light of the cybernetic concept: hours 7–20).

- G-2: *The Science of Being— as I see it today*, Lecture, 1970, London, England, hours 7B–8.
- X-15: *Divine Cybernetics*, (hours 9–10 from B-1).

Books by Max Kappeler:

The Four Levels of Spiritual Consciousness: Science itself, divine Science, absolute Christian Science, Christian Science, p. 49.

From Atomistic Thinking to Cybernetic Comprehensive Consciousness – Audio Code B-2

© 1970, 2005 Kappeler Institute for the Science of Being, PO Box 99735, Seattle, WA 98139-0735. All rights reserved.

Oneness
in “Science and Health with Key to the Scriptures”, by Mary Baker Eddy, Chapters I–XVI

| | WORD Man’s unity with God | CHRIST God’s unity with man | CHRISTIANITY One universe = God-idea | SCIENCE One integrated Science |
|-----------------------------|--|--|---|--|
| Word W | <i>I. PRAYER</i> Acceptance of man’s unity with God. A petitioner separated from God. | <i>V. ANIMAL MAGNETISM UNMASKED</i> Only one standpoint is at work: God. God only knows good. Going out from another standpoint than God. God works good and evil. | <i>IX. CREATION</i> Only one universe, the universe of the infinite One. A finite and an infinite universe. | <i>XIII. TEACHING CHRISTIAN SCIENCE</i> Only like can understand like. Knowing Science through Science. Instructing ignorance so as to become understanding. |
| Christ X | <i>II. ATONEMENT AND EUCHARIST</i> Exemplification of man’s unity with God, out of at-one-ment with God’s power. Man atoning out of himself or through vicarious efforts. | <i>VI. SCIENCE, THEOLOGY, MEDICINE</i> God with us: Immanuel, Revelation, and translation are one. God and we. Man has a mind of his own. | <i>X. SCIENCE OF BEING</i> Only one evolution of the universe: the spiritual. A material and a spiritual evolution. | <i>XIV. RECAPITULATION</i> Principle and idea is one. Science expressing itself through metaphysics. Metaphysics separate from Science. |
| Christianity Xty | <i>III. MARRIAGE</i> Man’s unity in God is: man’s unity with the universe. Man is an ego of his own. | <i>VII. PHYSIOLOGY</i> God is omnipotent in Truth and in belief. God and all conditions are one. Working from two standpoints. Serving two masters. | <i>XII. SOME OBJECTIONS ANSWERED</i> Principle and practice are one. Understanding separated from demonstration. | <i>XV. GENESIS</i> Principle expresses itself. God and Being is one. Creator and creation. |
| Science Sc | <i>IV. CHRISTIAN SCIENCE VERSUS SPIRITUALISM</i> Indivisibility of Spirit. Man’s understanding of God and God’s understanding are one Dividing Spirit into spirits. Understanding God with mortal’s understanding. | <i>VIII. FOOTSTEPS OF TRUTH</i> The coincidence of the divine and the human. There is only one I or Ego. Divinity separated from humanity. The personal I separated from the divine I. | <i>XI. CHRISTIAN SCIENCE PRACTICE</i> The health of God is the health of man. Applying ideas to disease. | <i>XVI. THE APOCALYPSE</i> Principle and idea operate as one complete transparency. Duality dissolved. |

From Metaphysics to Science

The ordered steps to finding our oneness with Being (Resolving the “personal I” into the “I Am”)

ascending way

Metaphysics: the contemplation of ideas

1. All is mental (*cogito, ergo sum*)
2. The mental can be good or evil
3. Thinking in terms of ideas
4. Thinking in terms of the synonyms for God

Science: the contemplation of the infinite One, including all ideas

5. Only the synonyms for God in us can be one with synonym of God
6. Life, Truth, and Love is the only “I” of us
7. The synonyms of God are the only “I” or Ego
8. The “I” is “I AM”

descending way

Science:

8. I AM that I Am
7. This I AM is the “I am” of all
6. This I AM is infinitely individualized as “individual I am”
5. This I AM has no other “I Am,” no “personal I”

Science including metaphysics:

4. This I AM is “the thinker” of us
3. This I AM gives us ideas/makes God’s thoughts and “my” thoughts identical
2. This I AM gives only good thoughts
1. This I AM makes us “the thought of” God and therefore, “I am” (*cogitor, ergo sum*)

References for “From Metaphysics to Science: The ordered steps to finding man’s oneness with Being”:

Books by Max Kappeler:

The Four Levels of Spiritual Consciousness: Science itself, divine Science, absolute Christian Science, Christian Science, pp. 7–9, 55–59.

From metaphysics to Science:

Books by Max Kappeler:

Animal Magnetism—Unmasked, pp. 184–192.

Books by John Doorly:

Talks at the Oxford Summer School, 1948, Vol. II, pp. 118–120.

Talks at the Oxford Summer School, 1949, Vol. II, pp. 131–132.

Recordings by Max Kappeler:

- B-2: *From Atomistic Thinking to Cybernetic Comprehensive Consciousness*, 1970, Ogunquit, ME, hour 23.
- D-2: *Divine Cybernetics: the proto-science, the integral Science*, 1969, Braunwald, Switzerland, hours 6–7.
- X-13: *The Eight Ordered Steps to Finding our Oneness with Being*, one hour from B2 (#23).

Recordings by Max Kappeler:

- A-4: *The Structure-principle of Being*, 1974, Wilmington, DE, hour 23.
- A-5: *A Seminar on the Seven Synonymous Terms for God*, 1975, Wilmington, DE, hours 19B-21
- C-1S: *CH. VI, Science, Theology, Medicine, The Structure of the Christian Science Textbook—Our Way of Life*, 1978, hours 10–11, 37
- B-1: *A Survey of the Fundamentals of Christian Science*, hours 3B–4.
- D-1: *The 4 Levels of Science*, 1967/68, London, England, hours 1, 6A.
- X-8: *Metaphysics contrasted with Science*, 2 hours from A-5 (#19B, 20, 21).

ascending way of understanding and descending way of demonstration:

Books by Max Kappeler:

The Four Levels of Spiritual Consciousness: Science itself, divine Science, absolute Christian Science, Christian Science, pp. 74–77.

Books by John Doorly:

Talks at the Oxford Summer School, 1949, Vol. I, pp. 21–24.

Talks on the Science of the Bible, #59 “blue-book,” pp. 13–16.

Talks on the Science of the Bible, #61 “blue-book,” pp. 3–10, 31–32 (progressive from objective to the subjective viewpoint).

Recordings by Max Kappeler:

- D-1: *The 4 Levels of Science*, 1967/68, London, England, hours 8B, 17–20.

ascending and descending in ‘The Apocalypse’:

Books by Max Kappeler:

The Structure of the Christian Science Textbook, Vol. I., pp. 177–185.

The Science of the Oneness of Being in the Christian Science Textbook, pp. 239–248.

Epitomes for the Spiritually Structured Interpretation of the Christian Science, ‘The Apocalypse’, pp. 3–4.

Books by John Doorly:

Talks on the Science of the Bible, #58 “blue-book,” pp. 9–16

From Atomistic Thinking to Cybernetic Comprehensive Consciousness – Audio Code B-2

© 1970, 2005 Kappeler Institute for the Science of Being, PO Box 99735, Seattle, WA 98139-0735. All rights reserved.

“ANIMAL MAGNETISM – UNMASKED”

(Development of the subject through the various revisions of *Science and Health with Key to the Scriptures* by Mary Baker Eddy)

Miscellaneous Writings, pp. 222:29–5; *Retrospection and Introspection*, pp. 37:21–38:26, by Mary Baker Eddy

| | |
|--|---|
| 1 st Edition (1875) MIND | No special chapter. The subject was treated in the chapter “Healing the Sick” (16 pages). Accent lies on observation, investigation, inquiring, gaining insight into the subject of mesmerism. |
| 2 nd Edition (1878) SPIRIT | Title of chapter: Mesmerism: (15 pages) Accent is on distinguishing between metaphysics and mesmerism, between “mind” and “Divine mind”. |
| 3 rd Edition SOUL | Title of chapter: “Demonology” (46 pages). Accent is on the malicious abuse of mesmerism, on the <i>modus operandi</i> of malicious malpractice. Now uses “Mind” capitalized. Basis of malpractice is animal nature. |
| 6 th Edition (1883) PRINCIPLE | Title of chapter: “Demonology” (12 pages). Accent is on impersonalizing animal magnetism. |
| 16 th Edition (1886) LIFE | Title of chapter: “Animal Magnetism” (13 pages). Accent is on dragon’s warfare against the woman, animal magnetism warring with the divine idea. Without a knowledge of animal magnetism, error continues and increases. 1886–91 Department on “Animal Magnetism” in Journal 1887 “Ways that are vain: (<i>Miscellany</i> , by Mary Baker Eddy, pp. 210–213)—was not put into Prose Works by Mrs. Eddy. 1889 “Malicious Animal Magnetism” (Christian Science Journal, February). 1890 “A Card” (Christian Science Journal, August). |
| 50 th Edition (1891) TRUTH | Title of chapter: “Animal Magnetism” (7 pages) Text similar to final edition. Dropped all of those passages referring to the struggle and warfare. Accent is on “doing right” which excludes animal magnetism. Evil is no power, no reality, only a belief—belief has not one quality of Truth. There is no transference of mortal thought and willpower. 1899 “What Our Leader Says” (<i>Miscellany</i> , by Mary Baker Eddy, p. 210). “Keep your mind filled with Truth and Love.” |
| 226 th Edition (1902) LOVE | Title of chapter “Animal Magnetism” (7 pages) Accent is on the nothingness of animal magnetism <ul style="list-style-type: none"> ▪ evil is a suppositional lie ▪ the Allness of God, good, is the answer to animal magnetism. 1910 Title “Animal Magnetism Uncovered” 1910 Title “Animal Magnetism Unmasked” (a few months later) |

Transcript of the lost 10 minutes of recording Tape B-2 #4B

EDITOR'S NOTE: After Tape 4B ends, there should be an additional 10 minutes or so of recording. This apparently was lost in the transfer from reel-to-reel to 60 minute audiocassette.

Below is the lost section from the original transcript. This transcript is not completely verbatim; it has been edited to aid understanding. There could be errors introduced by the transcriber.

LAST LINE FROM TAPE #4B: "And we've got here a standard, a measuring rod of ideas..."

"...where each term was very different from the other one. So that as we culture that and culture that, we get a round tone of what Mind is, of what Spirit is and what Soul is. Can you see that? That's the way we proceeded.

"Now having found that, we come to a quite different sense of Science. This morning I was taking the definition of what Science is, and I only took one part of it, namely where the dictionary says that:

Science. 'Science is knowledge reduced to law and embodied in a system.'

"It is Science which takes and interprets knowledge and shows the relationships. It's really analysis of what is. That is a scientific method of analysis. It takes an indefinite term, like God, and analyzes it step by step; first in the great categories of the synonymous terms, and then in further classifications of the ideas characterizing each synonymous term. But, the definition of Science goes further, and this is a major point, one which I want to make during these two weeks with you. One very important point—which raises opposition and query, but I am a tough old guy, you know, and if I see something which is right, I just go for it—Science is not only something which is used to analyze a situation, but Science should also give us the means of being creative. Oxford Dictionary says under the definition of Science that it is:

Science. 'A branch of study which is concerned either with a connected body of demonstrated truth or with observed facts, systematically classified....'

"That's what we have been doing here. We have systematically classified ideas. Perhaps we have gained about 100 or 120 ideas of Mind, and then perhaps another

100 of Spirit, of Soul perhaps only 50 or so. We had perhaps 500 to 600 definite ideas which we could clearly classify under the seven classifications of the synonymous terms. So we have done what Science demands, namely to classify the main ideas of Being so that those main ideas—which constitute Being—can be brought into a system of reference. As we have seen this morning, we have to classify them and bring them under the system of reference through the synonymous terms.

“But the definition of Science goes on and says:

‘...and which include trustworthy methods for the discovery of new truth within its own domain.’

“Now, this sounds very harmless, but it isn’t at all. It includes trustworthy methods for the discovery of new truth. If we want to apply this to Science, to Christian Science, it means that we want to be a revelator, a discoverer, and not just an analyzer or interpreter. What we have done up to now with the Textbook, you see, all this here, is really just the analysis or the interpretation of God. We do this until we have a real standard of ideas which constitute reality, or which constitute our Being. But now comes the second part of the definition of Science—which is really the main thing of any Science—namely, that when you have analyzed your subject, you begin to discover new Truth in it.”

FIRST LINE TAPE B-2, #5A

“Well, we started yesterday by seeing how atomistic thinking...”

ABBREVIATIONS
used to reference the work of Mary Baker Eddy

| | |
|------|--|
| Mis. | <i>Miscellaneous Writings</i> |
| My. | <i>Miscellany</i> |
| Ret. | <i>Retrospection and Introspection</i> |
| S&H | References from the Christian Science textbook, <i>Science and Health with Key to the Scriptures</i> by Mary Baker Eddy, will be noted with a page and line number, for example: (465:10). |

REFERENCES
for further study

BOOKS by Max Kappeler

A Recent Theory of Evolution and Its Implications
Compendium for the Study of Christian Science
The Four Levels of Spiritual Consciousness: /Science itself, divine Science, absolute Christian Science, Christian Science.
The Science of the Oneness of Being in the Christian Science Textbook
The Seven Synonyms for God

RECORDINGS by Max Kappeler

A-4 *The Structure-principle of Being*, 1974, Wilmington, DE
A-6V *Syllabus V*, 1980
B-1 *A Survey of the Fundamentals of Christian Science*
B-2 *From Atomistic Thinking to Cybernetic Comprehensive Consciousness*, 1970, Ogunquit, ME
D-4 *Divine Cybernetics and the Self-operating “Dimensional Laws” of the One Being, God: Word (Part I), Word (Part II), The Christ (Part III), Christianity (Part IV)*, 1971/72, New York, hour 12B
E-1 *The Structure of Being and its Universal Laws*, 1973, New York
G-2 *The Science of Being—As I See It Today*, 1970, London, England
X-15 *Divine Cybernetics*, (hours #9–10 from B-1).

BOOKS by John W. Doorly

The Pure Science of Christian Science(London: The Foundational Book Company for the John W. Doorly Trust, 1949)

BOOKS by Mary Baker Eddy

Miscellaneous Writings
Miscellany
Retrospection and Introspection
Science and Health with Key to the Scriptures

From Atomistic Thinking to Cybernetic Comprehensive Consciousness – Audio Code B-2

© 1970, 2005 Kappeler Institute for the Science of Being, PO Box 99735, Seattle, WA 98139-0735. All rights reserved.